

ENTRADA Y SALIDA,
ERASMO CASTELLANOS

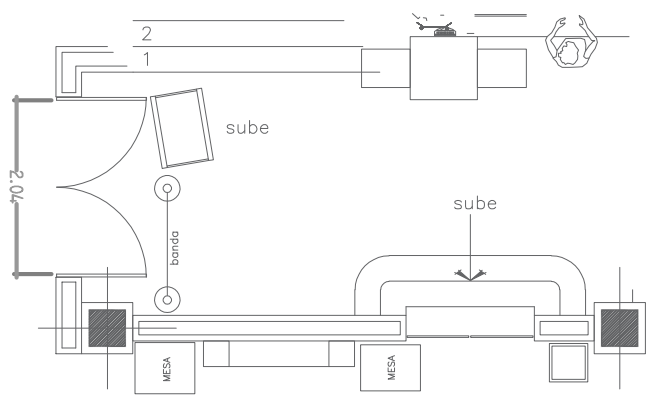

PUBLICACIONES
OFICIALES

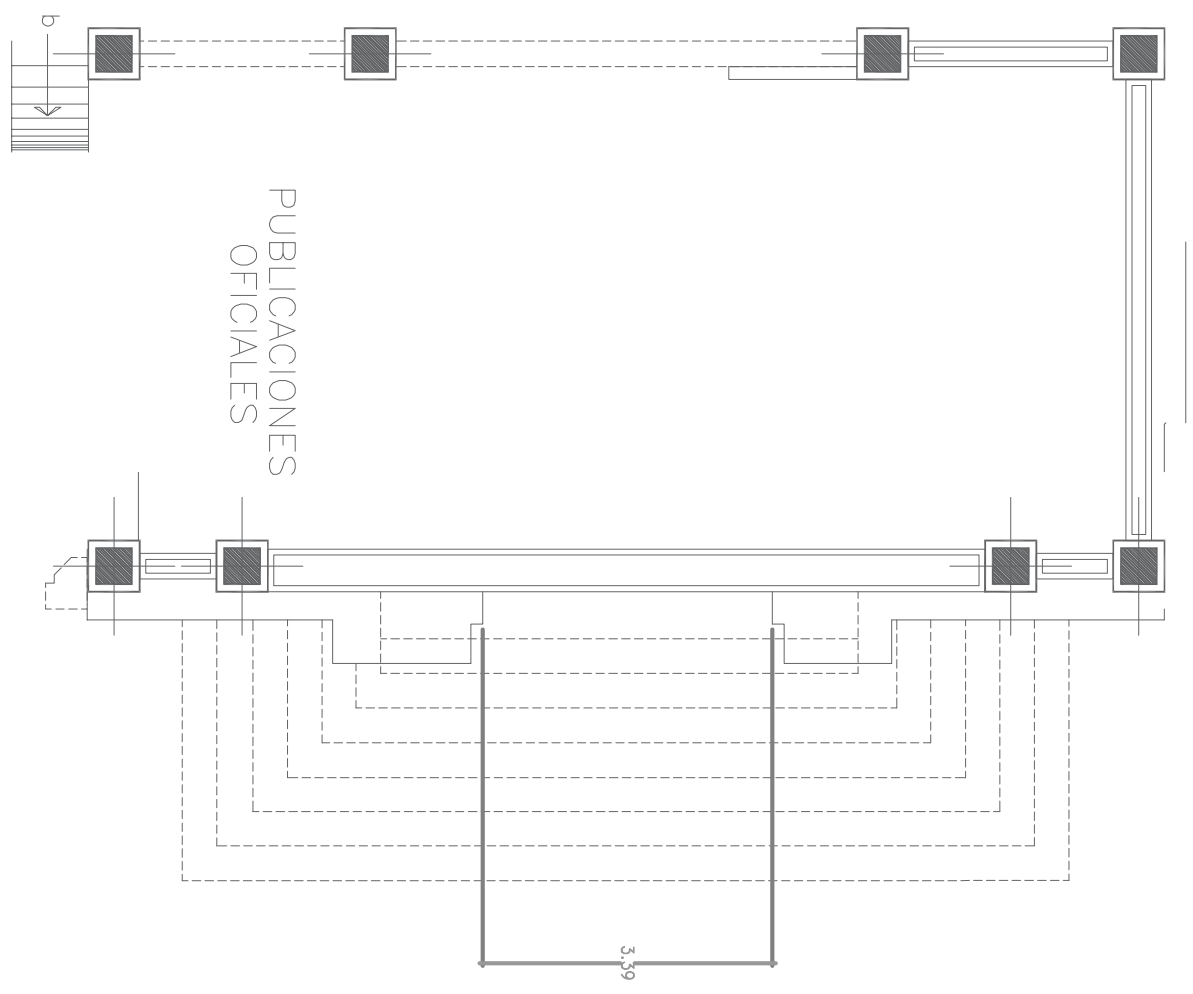

ENTRADA Y SALIDA,
PINO SUAREZ

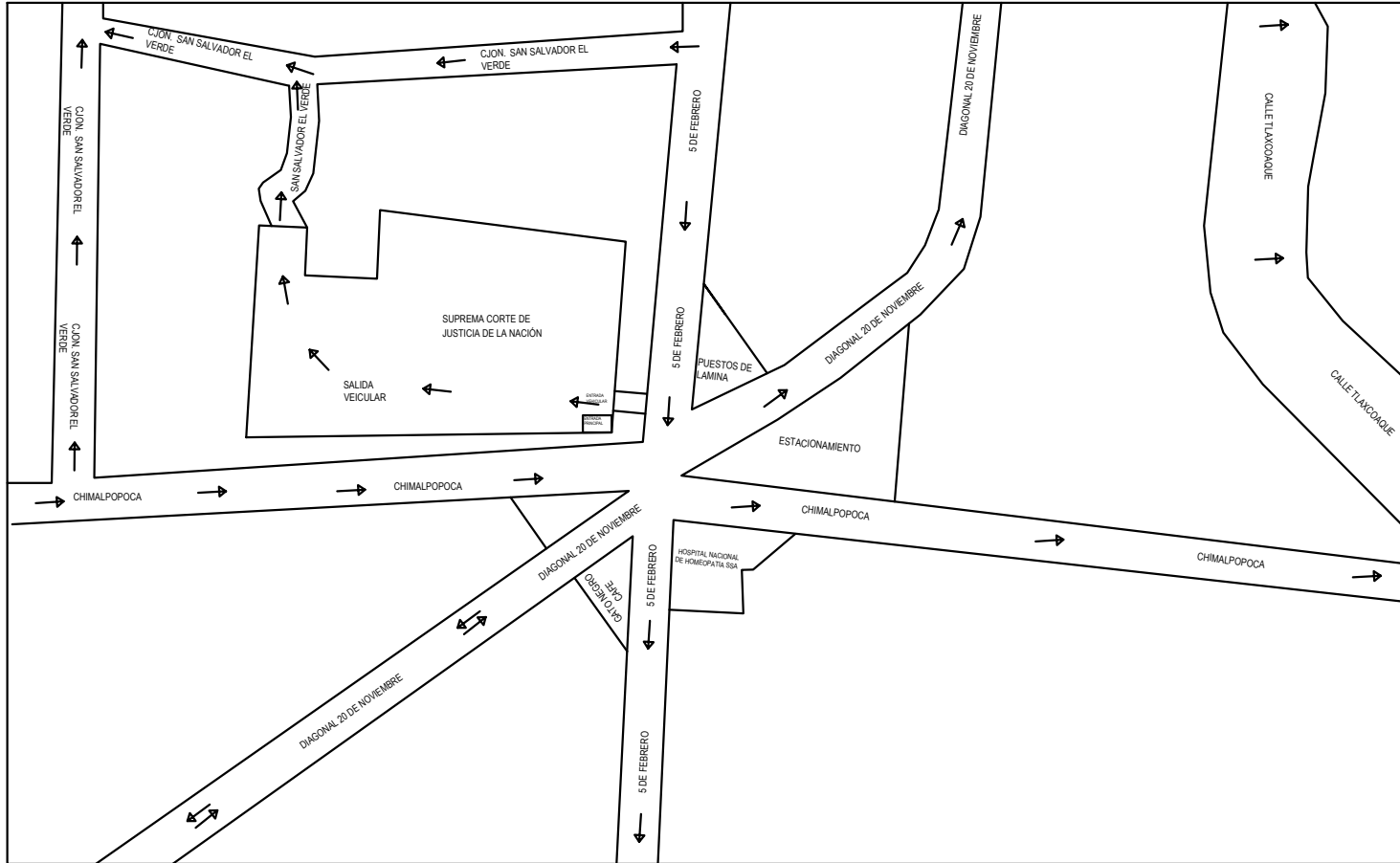

Instituto Politecnico Nacional

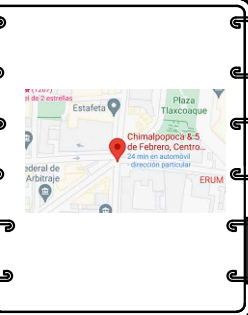

ELABORO:
RAMÍREZ HERNÁNDEZ ZULEMA
SAYURI,
SILVA JURADO JORGE PAULINO.

UBICACIÓN:
Chimalpopoca & 5 de Febrero, Centro, 06080
Ciudad de México, CDMX

Grupo: **ZAP'S**

CROQUIS

Escala: 1:50	Acotación: Metros Fecha: 10/jul/2021	No. Plano 1
-----------------	---	-----------------------

ACCESO VEHICULAR SEDE

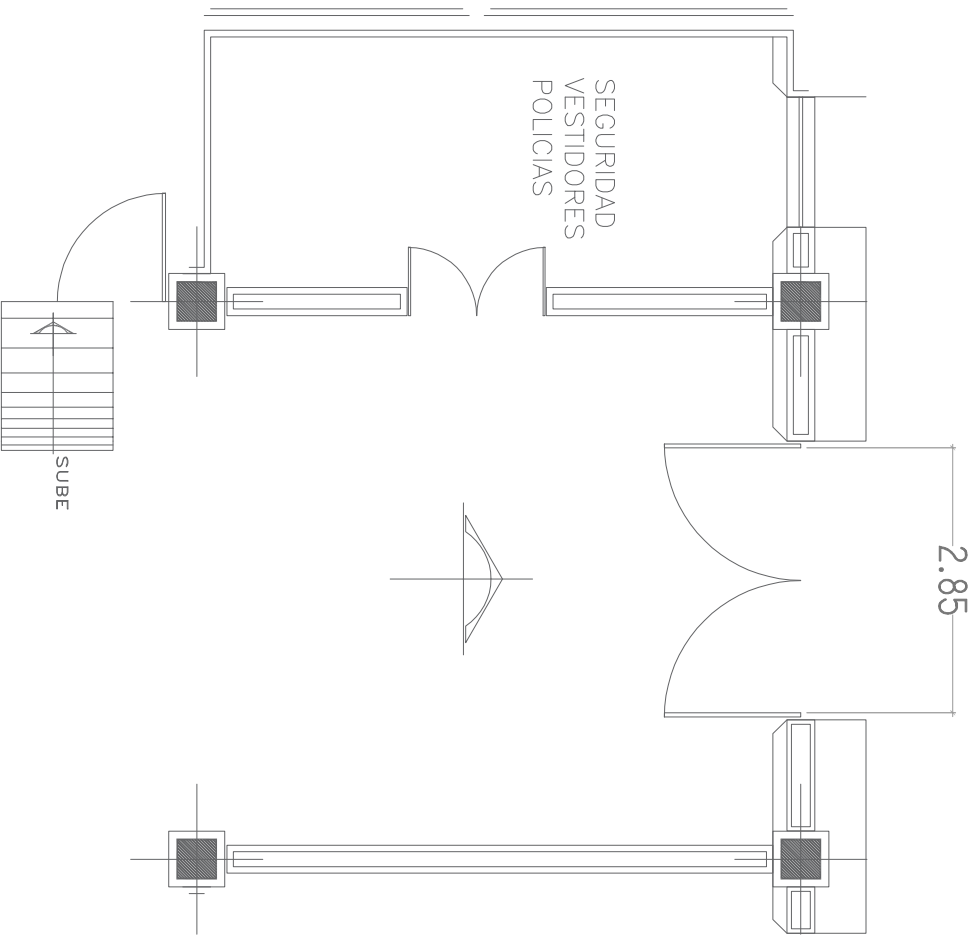

SALIDA VEHICULAR SEDE

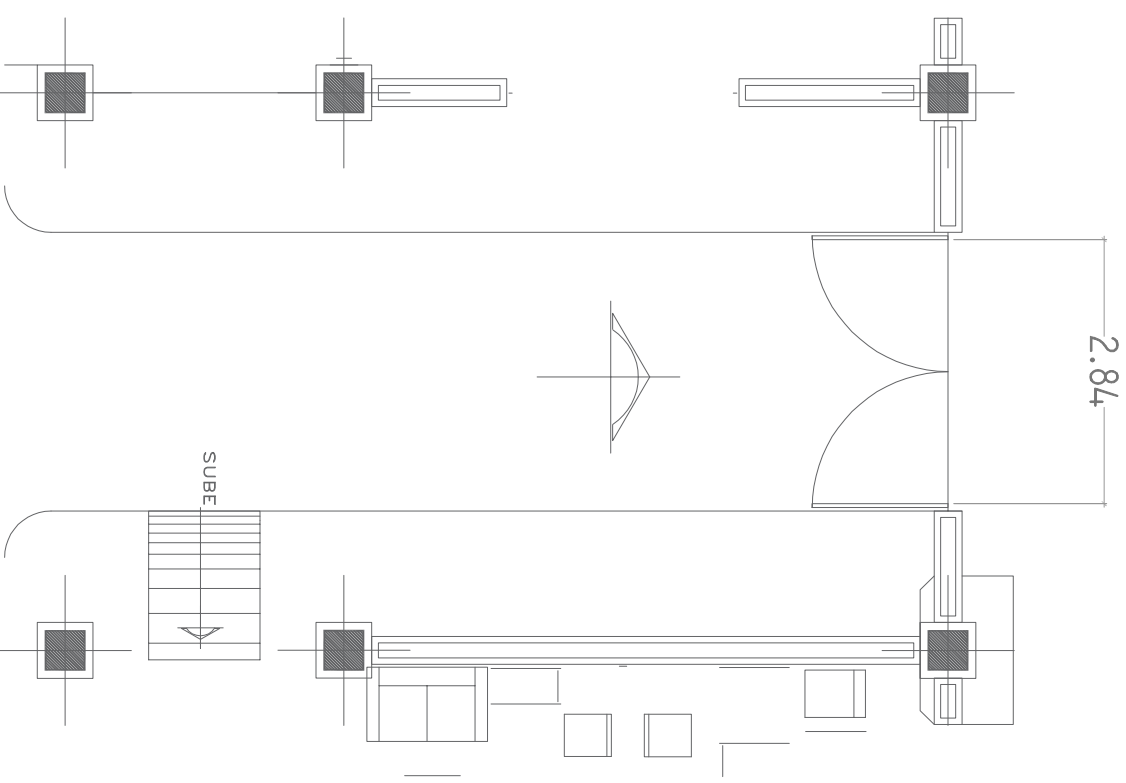

ACCESO PRINCIPAL

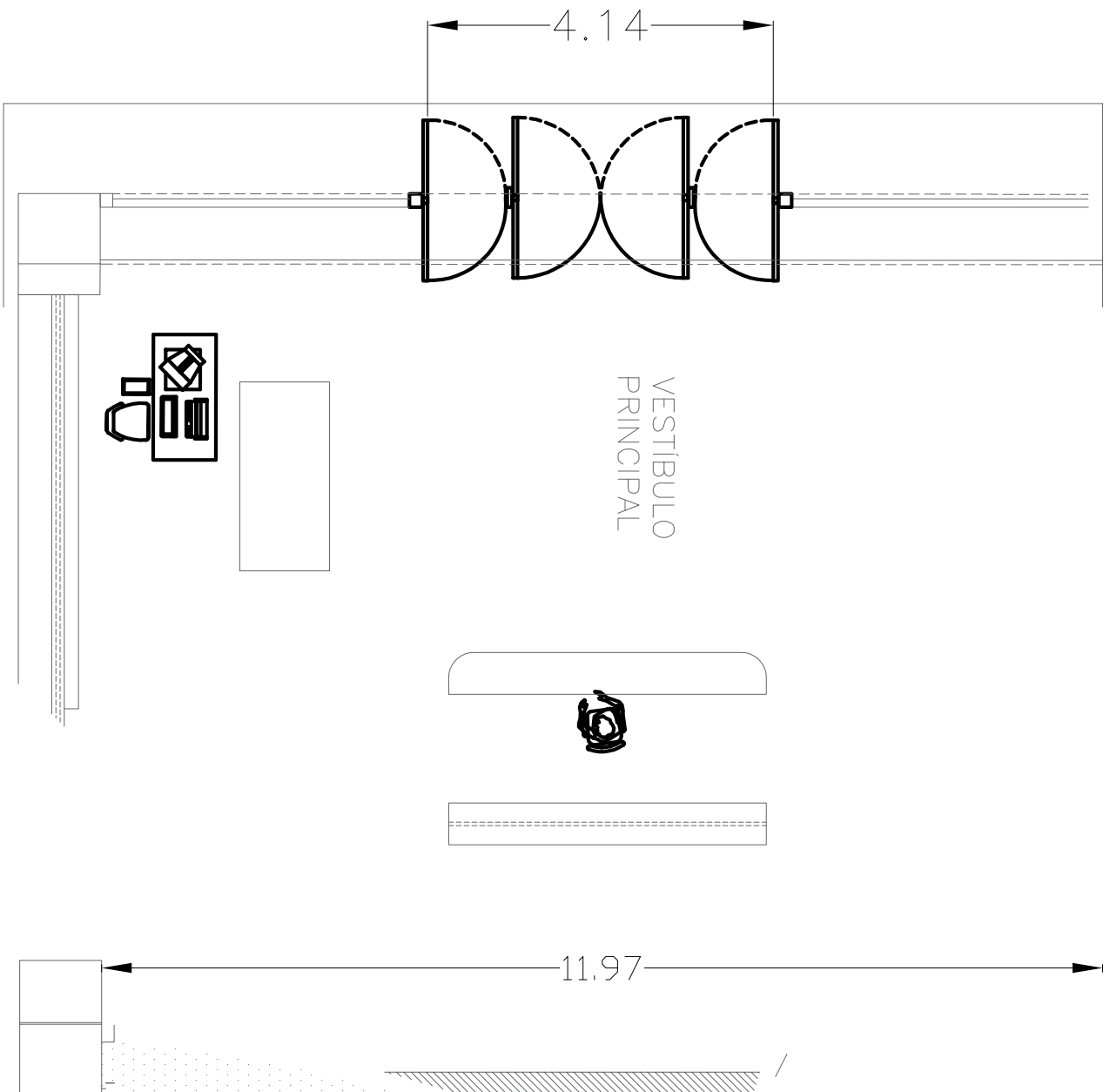

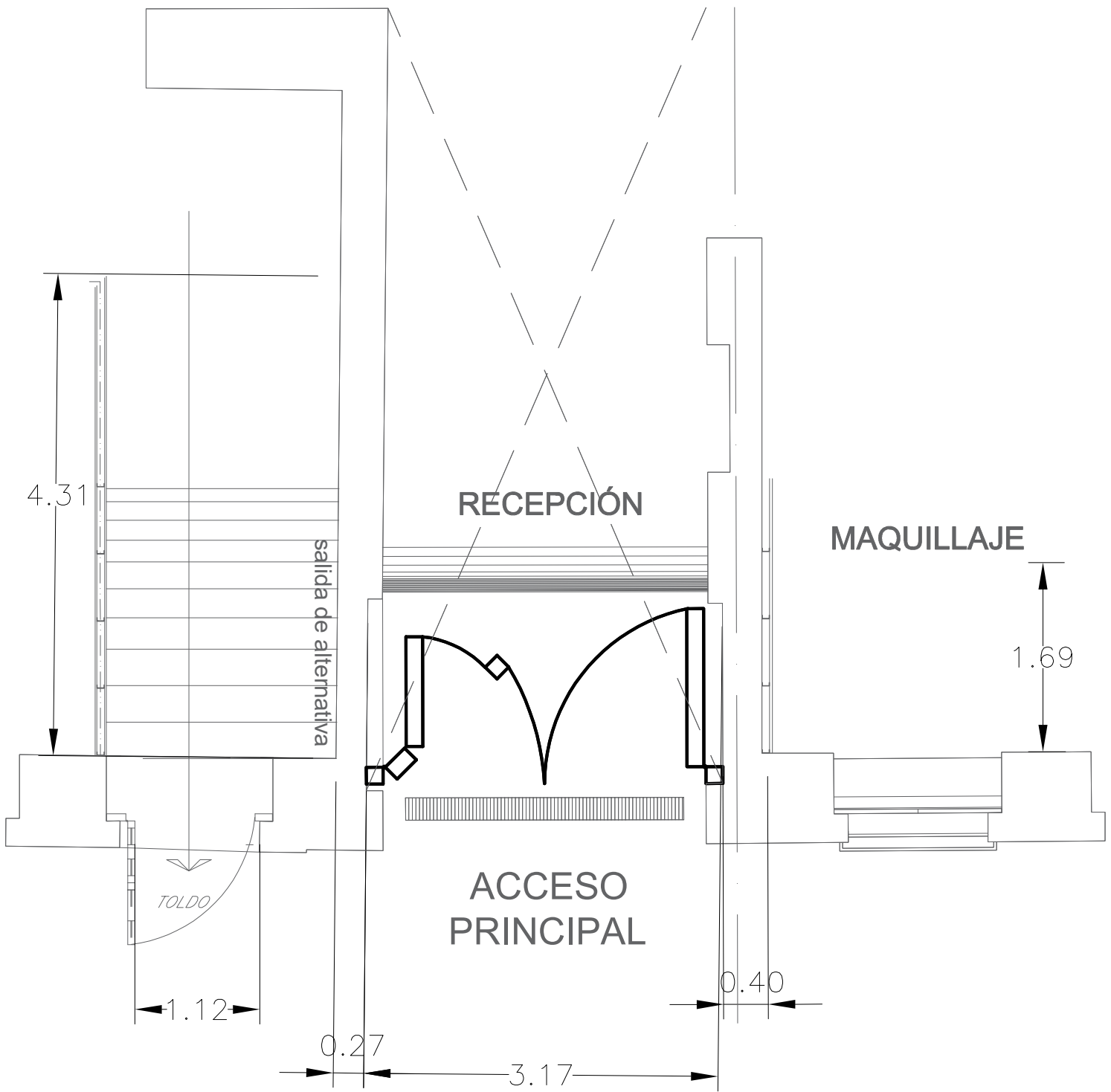

ACCESO PRINCIPAL JUSTICIA TV

ACCESO PRINCIPAL

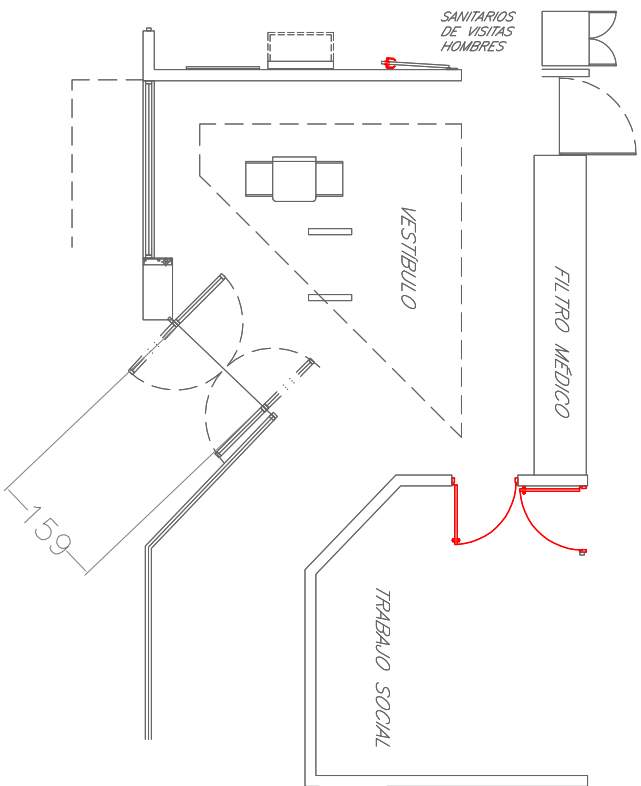

ACCESO DE SERVICIO

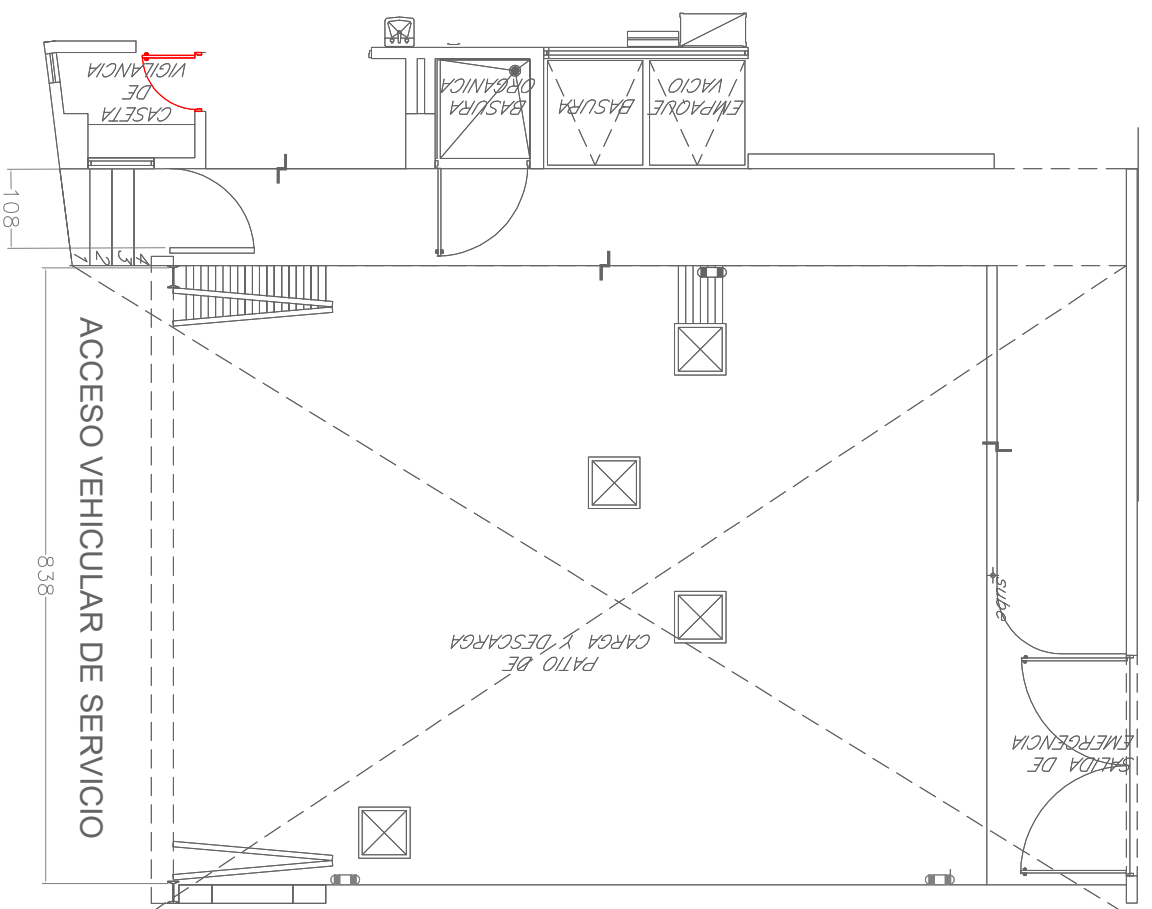

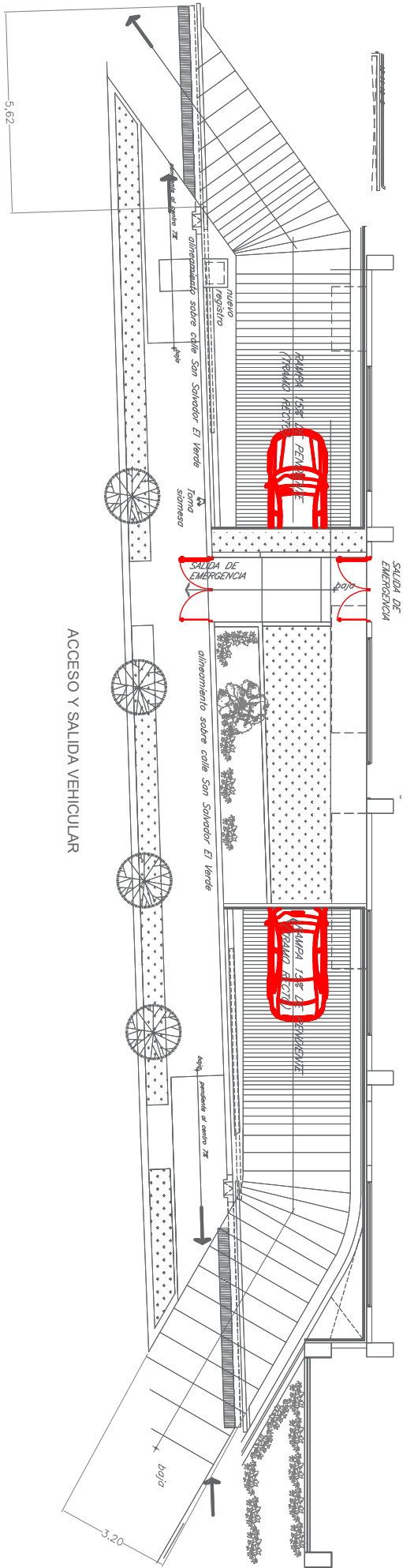

ACCESO PRINCIPAL BOLÍVAR

SALIDA VEHICULAR BOLÍVAR

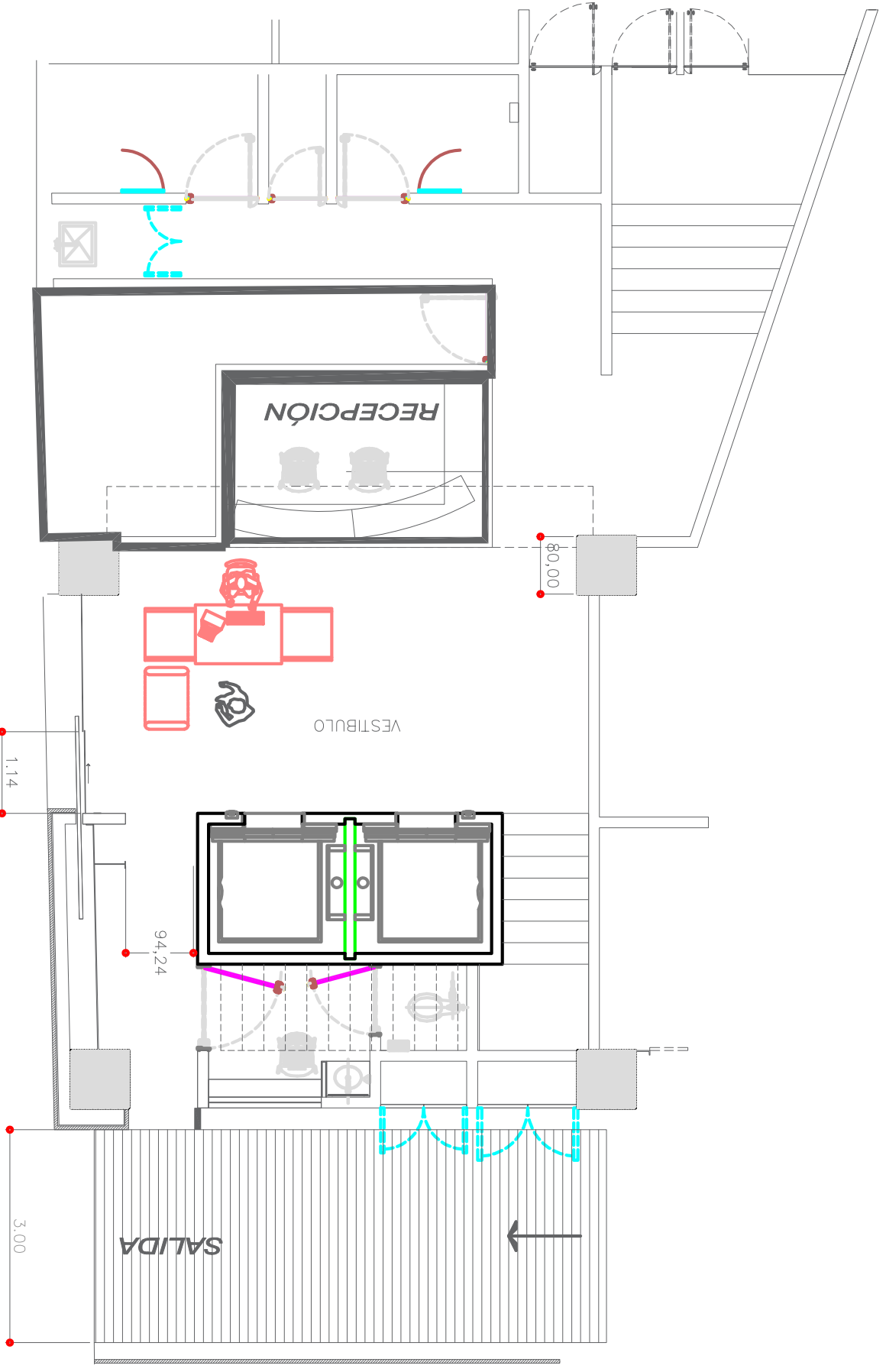

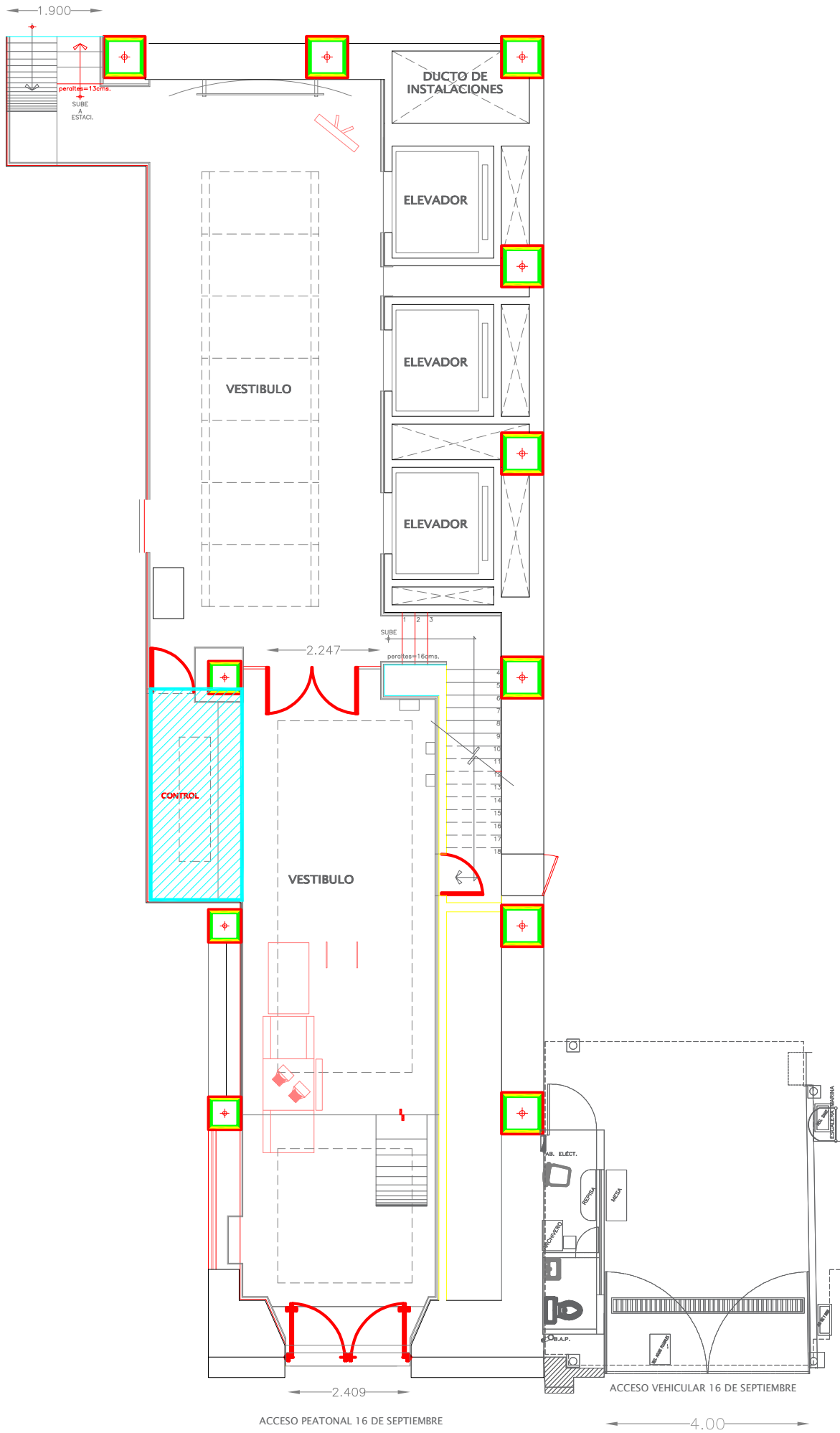

ACCESO PEATONAL 16 DE SEPTIEMBRE

ACCESO VEHICULAR 16 DE SEPTIEMBRE

4.00

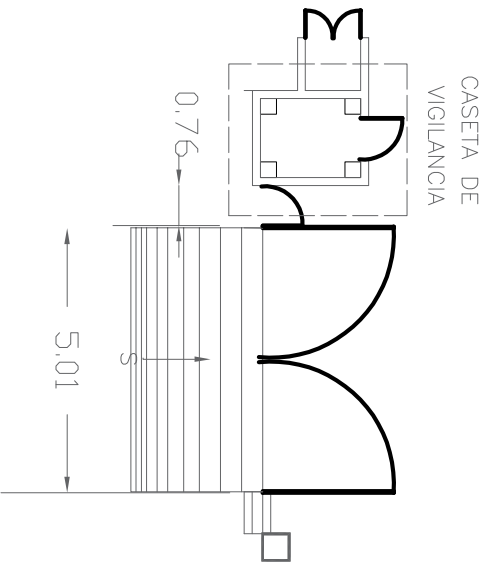

ACCESO Y SALIDA VEHICULAR Y PERSONAL

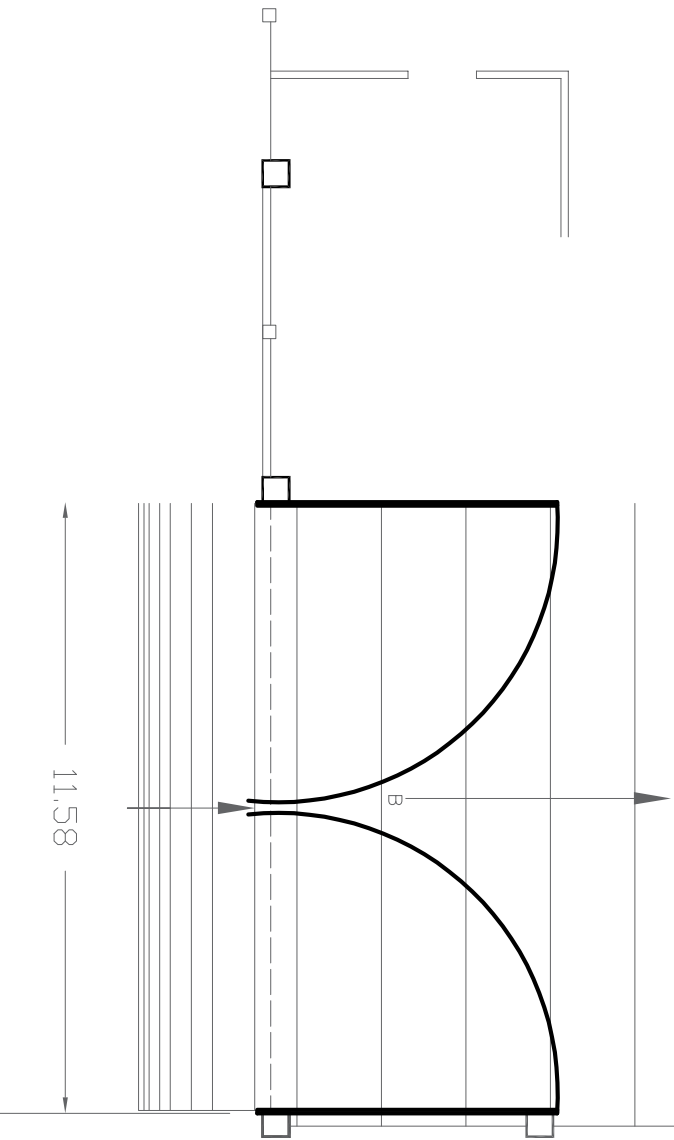

ACCESO A ANDEN DE CARGA Y DESCARGA